

SIDE VIEW

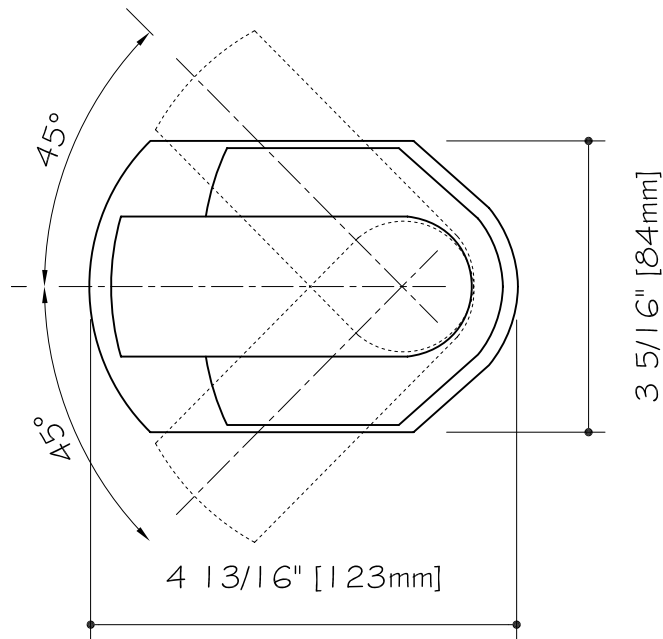

TOP VIEW

VG03055CH

THE MEASUREMENTS IN INCHES ARE ROUNDED TO THE NEAREST 1/16"

PACKAGE CONTENT

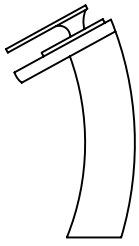

FAUCET



RUBBER
WASHER



PIN-2pc.



NUT-2pc.

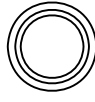

RUBBER
RING



STEEL
WASHER

TWO
FLEXIBLE
HOSE 15"
LONG

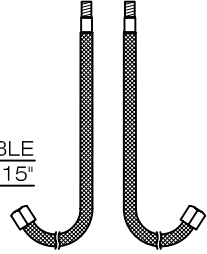

MAINTENANCE

Your new faucet is designed for years of trouble-free performance.

Keep it looking new by cleaning it periodically with a soft cloth. Avoid abrasive cleaners, steel wool and harsh chemicals as these will dull the finish and void your warranty.

TOOLS

Adjustable wrench
Groove joint pile
Plumber's putty
Pipe tape
Flat screwdriver

SAFETY TIPS

If you use soldering for the installation of the faucet, the seats cartridges and washers will have to be removed before using flame. Otherwise, warranty will be void on these parts

Protect your eyes with safety glasses when cutting or soldering water supply line

Cover your drain to avoid loosing parts

IMPORTANT POINTS

Prior to beginning installation, turn off the cold and hot water lines and open the old faucet to release build-up pressure.

When installing your new faucet, turn the connector nuts finger-tight, then use one wrench to anchor the fitting and a second wrench to tighten the nut one additional turn.

Connections that are too tight will reduce the integrity of the system.

Wrap all threaded connections with Teflon tape available at your local hardware or plumbing supply store. Always wrap in a clockwise direction.

All installations can vary depending on how your previous faucet was installed. Not all necessary supplies to install your faucet are included; however they are available wherever plumbing supplies are sold.

ASSEMBLY

NOTE: INSTALLATION MUST BE DONE BY A QUALIFIED, LICENSED PLUMBER.

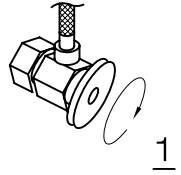

1 SHUT OFF WATER SUPPLY. REMOVE OLD FAUCET AND FLEXIBLE HOSES. CLEAN SINK SURFACE IN PREPARATION FOR THE NEW FAUCET.



2. SCREW MALE END OF THE FLEXIBLE HOSE TO THE FAUCET

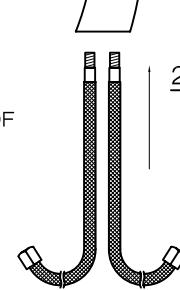

3. INSTALL PINS TO THE FAUCET

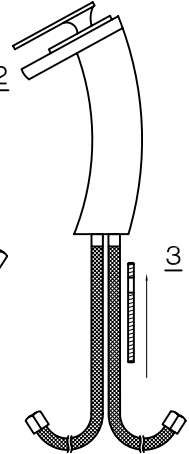

4. PLACE THE RUBBER RING IN TO THE SLOT AT THE BOTTOM OF THE FAUCET



5. PLACE NEW FAUCET IN THE POSITION ON THE SINK. FROM UNDER THE SINK, PUT RUBBER AND STEEL WASHERS AND THREAD NUTS ONTO THE PINS. TIGHTEN NUTS.

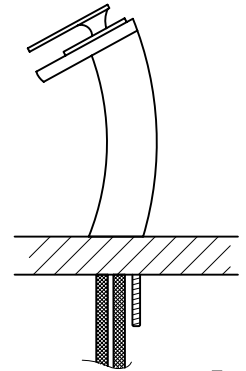

6. CONNECT THE FEMALE END OF FLEXIBLE HOSES TO THE COLD AND HOT WATER SUPPLY.

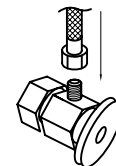

7. AFTER INSTALLATION IS COMPLETE TURN ON THE WATER SUPPLY VALVES AND ALLOW BOTH HOT AND COLD WATER TO RUN AT LEAST ONE MINUTE EACH. WHILE WATER IS RUNNING, CHECK FOR LEAKS, ESPECIALLY AT HOOK-UPS TO SUPPLY LINES. TIGHTENING NUTS SLIGHTLY WILL STOP ANY MINOR LEAKS.